

# CAST HOT LINE CLAMPS

## TYPE HLB/HLA

### (protected thread) Hot Line Clamps

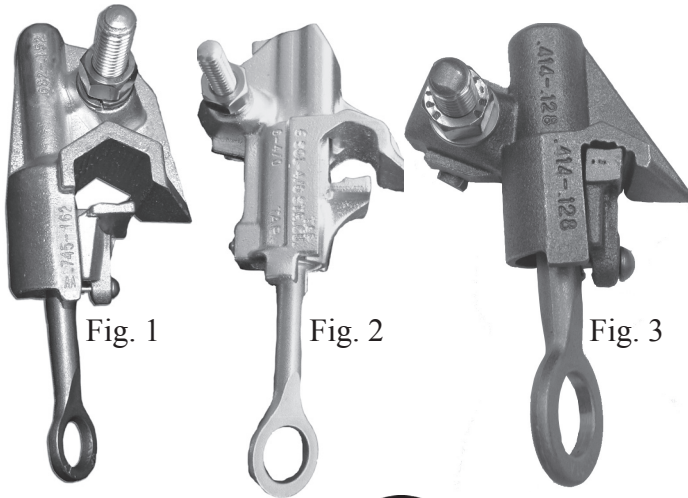

CMC® Hot Line Clamps are designed for installing or removing distribution tap connections with standard hot line tools and equipment.

CMC® Hot Line Clamps are cast from high strength bronze or aluminum alloy and forged eyebolts in stainless steel.

Eyebolt coated with high temperature grease, assuring easy turning in all weather conditions.

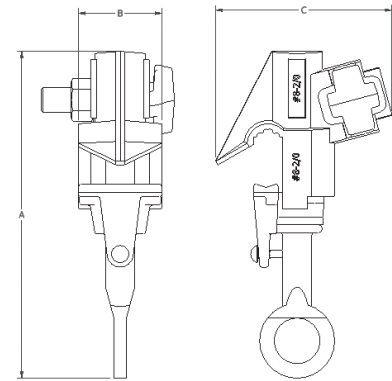

**Notes:**

1. *HLA indicates aluminum body clamps  
HLB indicates bronze body clamps*
2. *Add suffix "T" for tin plating*
3. *Add suffix "I" for packaging with inhibitor*

Catalog Number	Connection Type Run	Connection Type Tap	Run Dia.	Run	Tap Dia.	Tap	A	B	C	Tap Nut	Standard Pack	Figure Number
HLA 2/0	AL	AL/CU	.128"-.414"	#8 Sol-2/0 str.	.128"-.414"	#8 Sol-2/0 str.	4.50	1.25	2.75	9/16	25	3
HLA 2/0 LD	AL	AL/CU	.128"-.414"	#8 Sol-2/0 str.	.128"-.414"	#8 Sol-2/0 str.	4.50	1.25	3.12	9/16	25	3
HLB 2/0	CU	CU	.128"-.414"	#8 sol - 2/0 str.	.128"-.414"	#8 sol - 2/0 str.	4.50	1.25	2.75	9/16	25	3
HLB 2/0 LD	CU	CU	.128"-.414"	#8 Sol-2/0 str.	.128"-.414"	#8 Sol-2/0 str.	4.50	1.25	3.12	9/16	25	3
HLA400R	AL	AL/CU	.162"-.745"	#6 ACSR-336.4 MCM	.152"-.682"	#6 sol-4/0 str.	7.25	1.38	3.62	9/16	25	2
HLB400R	CU	CU	.162"-.745"	#6 sol - 400 MCM	.152"-.682"	#6 sol-4/0 str.	7.25	1.38	3.62	9/16	25	2
HLA 400	AL	AL/CU	.162"-.745"	#6 ACSR-336.4 MCM	.152"-.682"	#6 sol-4/0 str.	6.50	1.75	2.50	3/4	25	1
HLB-400	CU	CU	.162"-.745"	#6 sol - 400 MCM	.152"-.682"	#6 sol-4/0 str.	6.50	1.75	2.50	3/4	25	1
HLA 800	AL	AL/CU	.502"-.1.031"	4/0 ACSR-800 MCM	.198"-.703"	#4 sol-350 MCM	6.50	2.00	3.00	3/4	25	1
HLB 800	CU	CU	.502"-.1.031"	4/0 ACSR-800 MCM	.198"-.703"	#4 sol-350 MCM	6.50	2.00	3.00	3/4	25	1

# TRANSFORMER EYEBOLT CONNECTORS

## TYPE NP / PTS

DUAL-RATED CONNECTORS  
FOR ALUMINUM OR COPPER CONDUCTORS

- Clear plated for low-contact resistance.
- Fully tested to ANSI C119.4 for Class ‘A’ connectors.
- For installation on equipment secondary transformers.
- Stud is electro-tin plated.
- Supplied with aluminum radial-tipped set-screws.
- Connector fabricated from 6061-T6 aluminum alloy for conductivity and strength.
- Includes CO-OX oxide inhibitor in all conductor holes.
- Each unit individually wrapped and labeled for ease of identification and cleanliness.
- For installation, CMC® recommends the use of a 9” insulated Allen wrench.

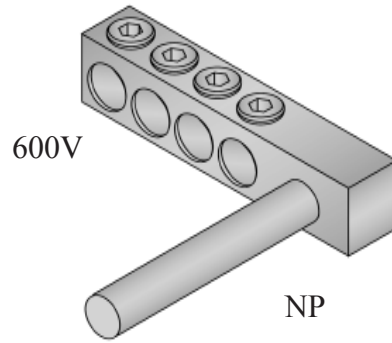

*Catalog Number	No. of Cond.	Cond. Range AWG	Stud Dia. Inches	Stud Length Inches	H	W	L	Cover Only
					Dimensions - Inches			
					Dimensions - (mm)			
NP2-1/0I	2	1/0-14	0.38	3.50	0.75	0.56	1.97	NPC2-1/0
NP3-1/0I	3	1/0-14	0.38	3.50	0.75	0.56	2.59	NPC3-1/0
NP4-1/0I	4	1/0-14	0.38	3.50	0.75	0.56	3.22	NPC4-1/0
NP2-250I	2	250-12	0.50	4.00	1.13	0.88	2.69	NPC2-250
			12.70	101.60	28.70	22.35	68.33	
NP3-250I	3	250-12	0.50	4.00	1.13	0.88	3.64	NPC3-250
			12.70	101.60	28.70	22.35	92.46	
NP4-250I	4	250-12	0.50	4.00	1.13	0.88	4.58	NPC4-250
			12.70	101.60	28.70	22.35	116.33	
NP6-250I	6	250-12	0.50	4.00	1.13	0.88	6.46	NPC6-250
			12.70	101.60	28.70	22.35	164.08	
NP8-250I	8	250-12	0.50	4.00	1.13	0.88	8.36	NPC8-250
			12.70	101.60	28.70	22.35	212.34	
NP2-350I	2	350-12	0.50	4.00	1.25	1.00	2.97	NPC3-350
			12.70	101.60	35.05	25.40	75.44	
NP3-350I	3	350-12	0.50	4.00	1.25	1.00	4.00	NPC3-350
			12.70	101.60	35.05	25.40	101.60	
NP4-350I	4	350-12	0.50	4.00	1.25	1.00	5.03	NPC4-350
			12.70	101.60	35.05	25.40	127.76	
NP6-350I	6	350-12	0.50	4.00	1.25	1.00	7.09	NPC6-350
			12.70	101.60	35.05	25.40	180.09	
NP8-350I	8	350-12	0.50	4.00	1.25	1.00	9.14	NPC8-350
			12.70	101.60	35.05	25.40	232.16	

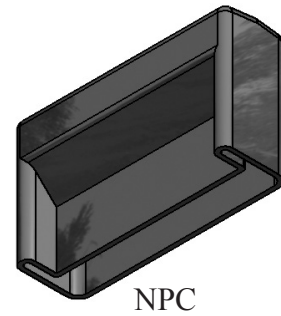

Notes: \*Add suffix "C" to order with black plastisol cover  
For omission of co-ox oxide inhibitor, delete suffix "I".

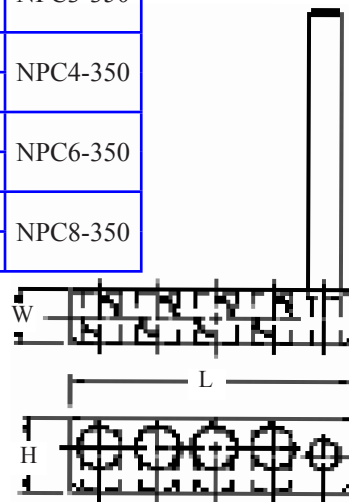

# TRANSFORMER EYEBOLT CONNECTORS

## TYPE NP

### Transformer Eyebolt Connectors

600V

DUAL-RATED CONNECTORS  
FOR ALUMINUM OR COPPER CONDUCTORS

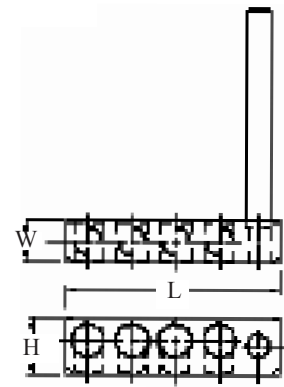

- Clear plated for low-contact resistance.
- Fully tested to ANSI C119.4 for Class 'A' connectors.
- For installation on equipment secondary transformers.
- Copper stud is electro-tin plated.
- Supplied with aluminum radial-tipped set-screws.
- Connector fabricated from 6061-T6 aluminum alloy for conductivity and strength.
- Includes CO-OX oxide inhibitor in all conductor holes.
- Each unit individually wrapped and labeled for ease of identification and cleanliness.
- For installation, CMC® recommends the use of a 9" insulated Allen wrench.

*Catalog Number	No. of Cond.	Cond. Range AWG MM2	Stud Dia. Inches	Stud Length Inches	H	W	L	Cover Only
					Dimensions - Inches			
					Dimensions - (mm)			
NP2-500I	2	500-10	0.75	4.50	1.63	1.00	3.51	NPC2-500
		240-4	19.05	114.30	41.40	25.40	89.15	
NP3-500I	3	500-10	0.75	4.50	1.63	1.00	4.72	NPC3-500
		240-4	19.05	114.30	41.40	25.40	119.89	
NP4-500I	4	500-10	0.75	4.50	1.63	1.00	5.93	NPC4-500
		240-4	19.05	114.30	41.40	25.40	150.62	
NP6-500I	6	500-10	0.75	4.50	1.63	1.00	8.35	NPC6-500
		240-4	19.05	114.30	41.40	25.40	212.09	
NP8-500I	8	500-10	0.75	4.50	1.63	1.00	10.77	NPC8-500
		240-4	19.05	114.30	41.40	25.40	273.56	
NP2-750I	2	750-2	0.75	4.50	1.88	1.37	4.00	NPC2-750
		300-25	19.05	114.30	47.75	34.92	101.60	
NP3-750I	3	750-2	0.75	4.50	1.88	1.37	5.38	NPC3-750
		300-25	19.05	114.30	47.75	34.92	136.65	
NP4-750I	4	750-2	0.75	4.50	1.88	1.374	6.75	NPC4-750
		300-25	19.05	114.30	47.75	34.92	171.45	
NP6-750I	6	750-2	0.75	4.50	1.88	1.37	9.50	NPC6-750
		300-25	19.05	114.30	47.75	34.92	241.30	
NP8-750I	8	750-2	0.75	4.50	1.88	1.37	12.25	NPC8-750
		300-25	19.05	114.30	47.75	34.92	311.15	

Note: For omission of CO-OX oxide inhibitor, delete suffix "I". For Streetlight tap add suffix "SL".

\*Add suffix "C" to order with black plastisol cover

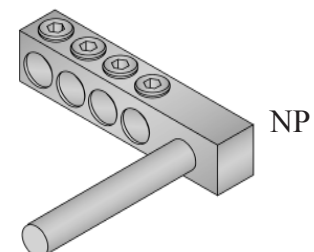
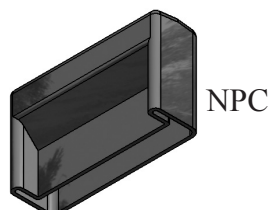

# TRANSFORMER EYEBOLT CONNECTORS

600V

## TYPE NPP

### DUAL-RATED CONNECTORS FOR ALUMINUM OR COPPER CONDUCTORS

- Clear plated for low-contact resistance.
  - Fully tested to ANSI C119.4 for Class ‘A’ connectors.
  - For installation on equipment secondary transformers.
  - Stud is electro-tin plated.
  - Supplied with aluminum radial-tipped set-screws.
  - Connector fabricated from 6061-T6 aluminum alloy for conductivity and strength.
- Includes CO-OX oxide inhibitor in all conductor holes.
  - Each unit individually wrapped and labeled for ease of identification and cleanliness.
  - For installation, CMC® recommends the use of a 9” insulated Allen wrench.

Catalog Number	No. of Cond.	Cond. Range AWG	Stud Dia. Inches	Stud Length Inches	H	W	L
					Dimensions - Inches		
NPP3-250I	3	250-12	.50	4.00	1.13	0.88	3.64
NPP4-250I	4	250-12	.50	4.00	1.13	0.88	4.58
NPP5-250I	5	250-12	.50	4.00	1.13	0.88	5.75
NPP6-250I	6	250-12	.50	4.00	1.13	0.88	6.46
NPP8-250I	8	250-12	.50	4.00	1.13	0.88	8.36
NPP3-350I	3	350-12	.50	4.00	1.25	1.00	4.00
NPP4-350I	4	350-12	.50	4.00	1.25	1.00	5.03
NPP5-350I	5	350-12	.50	4.00	1.25	1.00	6.30
NPP6-350I	6	350-12	.50	4.00	1.25	1.00	7.09
NPP8-350I	8	350-12	.50	4.00	1.25	1.00	9.14
NPP3-500I	3	500-10	.75	4.50	1.63	1.00	4.72
NPP4-500I	4	500-10	.75	4.50	1.63	1.00	5.93
NPP5-500I	5	500-10	.75	4.50	1.63	1.00	7.45
NPP6-500I	6	500-10	.75	4.50	1.63	1.00	8.34
NPP8-500I	8	500-10	.75	4.50	1.63	1.00	10.77

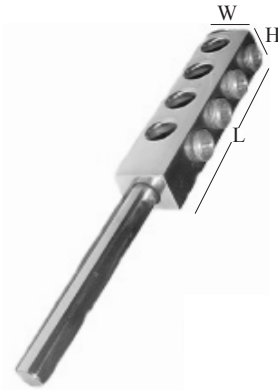

*Note: For omission of CO-OX oxide inhibitor delete suffix - "I"..  
Street light tap available — add suffix "SL" to catalog number*

# TRANSFORMER EYEBOLT CONNECTORS

## TYPE NPB (Blind Hole Wire Port)

600V

### DUAL-RATED CONNECTORS FOR ALUMINUM OR COPPER CONDUCTORS

- For moisture resistance, conductor ports are not drilled through the body.
- Clear plated for low-contact resistance.
- Fully tested to ANSI C119.4 for Class ‘A’ connectors.
- For installation on equipment secondary adaptors.
- Stud is electro-tin plated.
- Supplied with aluminum radial-tipped set-screws.
- Connector fabricated from 6061-T6 aluminum alloy for conductivity and strength.
- Includes CO-OX oxide inhibitor in all conductor holes.
- Each unit individually wrapped and labeled for ease of identification and cleanliness.
- For installation, CMC® recommends the use of a 9” insulated Allen wrench.

Catalog Number	No. of Cond.	Cond. Range	Stud Dia. Inches	Stud Length Inches	H	W	L
					Dimensions - Inches		
NPB4-4/0I	4	4/0-14	0.50	4.00	1.87	1.35	4.00
NPB2-350I	2	350-12	0.50	4.00	1.375	1.59	2.98
NPB3-350I	3	350-12	0.50	4.00	1.375	1.59	3.99
NPB4-350I	4	350-12	0.50	4.00	1.375	1.59	5.03
NPB6-350I	6	350-12	0.50	4.00	1.375	1.59	7.09
NPB2-500I	2	500-10	0.75	4.00	1.75	2.00	3.59
NPB2-750I	2	750-2	0.75	4.00	1.75	2.00	4.00
NPB4-500I	4	500-10	0.75	4.00	1.75	2.00	6.06

*Note: For omission of CO-OX oxide inhibitor, delete suffix “I”..  
Also, street light tap available, add suffix “SL” to the catalog number.*

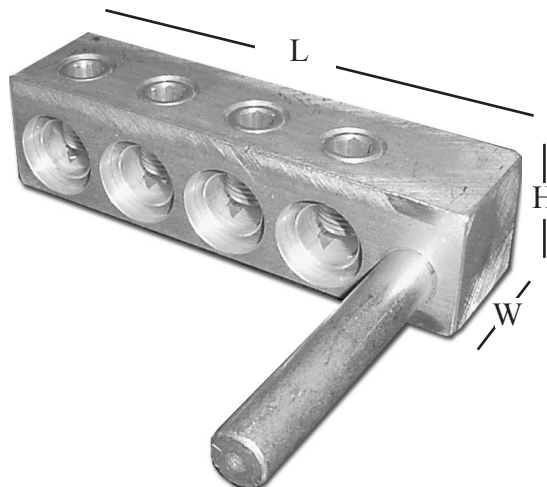

# COMPRESSION CONNECTORS

## TYPE PT

600V

### Aluminum Pin Terminal

- Tinned copper rod factory crimped into an aluminum compression sleeve. Cavities are pre-filled with electrical joint compound and capped.
- Pin terminals are widely used in clamp-type plated bronze connectors, common to pole-type transformers, disconnect switches, cutouts and lightning arrestors, to allow aluminum conductors to be connected. The transition from copper to aluminum is made within a sealed compression joint to assure protection from bi-metallic corrosion.

Catalog Number	Wire Range			"D" Nom. Pin Diameter	"p" Length Inches	"L" Length Inches	Common Crimping Die Codes
	Aluminum	ACSR	Dia. Range Min. - Max.				
PT64-2.5	4 Sol. 6 Str. & 6 Comp.	6	.16-206	4 Sol.	2.50	4.625	EE1-81 Burndy BG, 243 Kearney 5/8 Alcoa 08AH T&B TU (52) Anderson VC5, VC6
PT44-2.5	2 Sol. 3-4 Str. & 4 Comp.	4	.204-258				
PT24-2.5	1-2 Str. & 2 Comp.	2	.268-.328				
PT102S-2.5	1/0 Str. & 1/0 Comp.	1/0	.336-.398				
PT102-6	1/0 Str. & 1/0-2/0 Comp.	1/0	.336-.398	2 Sol.	6.00	9.875	EE1-11A Burndy 249 or 840 Kearney 840 Somerset TX or 76 Alcoa 11 AH Anderson VC5
PT2010-6	2/0 Str. & 3/0 Comp.	2/0	.414-.448	1/0 Sol.			
PT3010-6	3/0 Str. & 4/0 Comp.	3/0	.442-.502	3/8			
PT4020-6	4/0-250 Str. 250 Comp	4/0	.552-.575	4/0 Sol.			
PT34940-6	300-350 Str. 350 Comp.		.618-.684				
PT30050-6	250-300 Str. 300-350 Comp. Str.	4/0 & 200-18/1	.564-.630	4/0 Sol.	6.00	11.00	EE1-13A; Alcoa 13 AH Kearney 11/8 Burdy 316, 655 or 706 Somerset - T&B 96 Anderson VC6
PT35050-6	300-350 Str. 350 Comp.	336-18/1 & 336-36/1	.618-.684				
PT40050-6	336-400 Str. 500 Comp. Str.	336-18/1 397-36/1	.666-.741				
PT50050-6	450-500 Str. 600 Comp. Str.	397-18/1 477-36/1	.743-.814				
PT45062-6	450-500 Str. 600 Comp. Str.	397-18/1-477-341	.743-.814	5/8	6.00	12.00	EE1-14A; Alcoa 13 AH; Kearney 1-15/16; Anderson VC Burndy 317, 327 or 719 Somerset - T&B 106 Burndy 301, 342, 608, 722 or 786 Kearney 11/2 Alcoa 24AH Somerset-T&B 125 Anderson VC8
PT55062-6	500-556.5 Str.	477-18/1-556-18/1	.811-.879	5/8	6.00	12.25	
PT70062-6	600-700 Str. 750-800 Comp. Str.	605-36/1-636-36/1	.883-.996				
PT80075-6	700-800 Str. 1000 Comp.	605-26/7-716-36/1	.964-1.031	3/4	6.00	12.25	
PT90075-6	800-900 Str.	715-54/7 795-36/1 & 795-54/7	1.031-1.094				
PT100087-6	900-1033 Str.	795-26/17-954-54/7	1.092-1.196	7/8	6.00	12.50	Burndy 292, 302, 352, 579 or 725; Alcoa 30 AH; T&B 150; Kearney 13/4

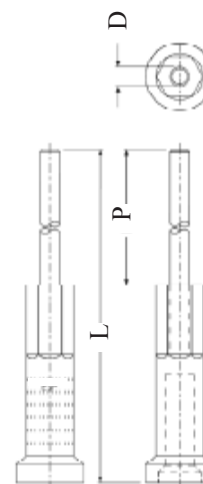
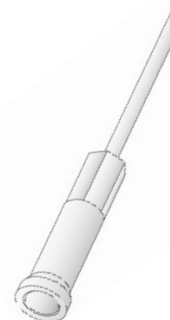

Various pin lengths available.

# COMPRESSION CONNECTORS

## TYPE SPT

### Shrouded Aluminum Pin Terminals

600V

- Shroud accepts insulation of conductors.
- Tinned copper rod factory crimped into an aluminum compression sleeve. Cavities are pre-filled with electrical joint compound and capped.
- Pin terminals are widely used in clamp-type plated bronze connectors, common to pole-type transformers, disconnect switches, cutouts and lightning arrestors, to allow aluminum conductors to be connected. The transition from copper to aluminum is made within a sealed compression joint to assure protection from bi-metallic corrosion.

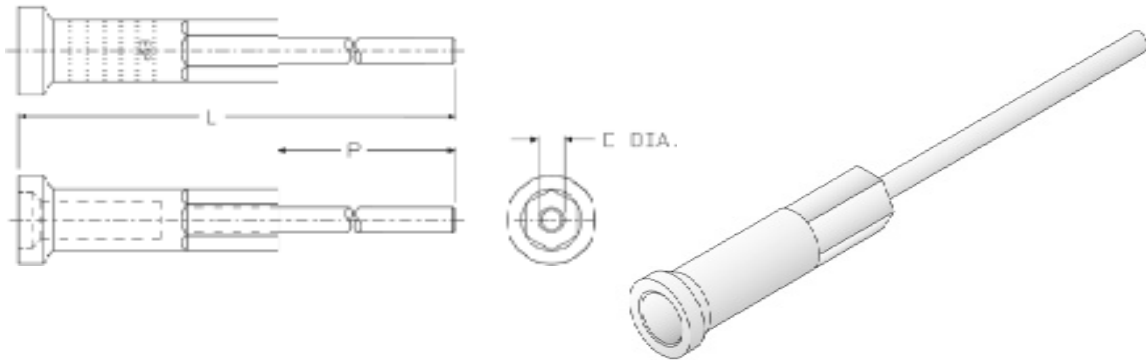

Catalog Number	Wire Range			“D” Nom. Pin Diameter	“P” Length - Inches	“L” Length - Inches	Common Crimping Die Codes
	Aluminum	ACSR	Dia. Range Min. - Max.				
SPT44	2 Sol. 3-4 Str. & 4 Comp.	4	.204 - .258	4 Sol.	2.00	5.37	EE1-81 Burndy BG, 243 Kearney 5/8 Alcoa 08AH T&B TU (52) Anderson VC5, VC6
SPT24	1 - 2 Str. & 2 Comp. Str.	2	.268 - .328		2.00	5.50	
SPT102S	1/0 Str. 1/0 Comp.	1/0	.336 - .398	2 Sol.	2.00	5.75	
SPT2010	2/0 Str. 3/0 Comp.	2/0	.388 - .448	1/0 Sol.	4.00	7.00	
SPT3010	3/0 Str. 4/0 Comp.	3/0	.442 - .502	3/8	4.00	7.25	
SPT4020	4/0 - 250 Str. 250 Comp.	4/0	.511 - .575		3.72	7.00	
SPT34940	300-350 Str. 350 Comp.		.618 - .684	4/0 Sol.	6.00	11.00	EE1- 11A Burndy 249 or 840 Kearney 840 Somerset TX or 76 Alcoa 11 AH Anderson VC6



# COMPRESSION CONNECTORS

600V

## TYPE SPT

### Shrouded Aluminum Pin Terminals

- Shroud accepts insulation of conductors.
- Tinned copper rod factory crimped into an aluminum compression sleeve. Cavities are pre-filled with electrical joint compound and capped.
- Pin terminals are widely used in clamp-type plated bronze connectors, common to pole-type transformers, disconnect switches, cutouts and lightning arrestors, to allow aluminum conductors to be connected. The transition from copper to aluminum is made within a sealed compression joint to assure protection from bi-metallic corrosion.

Catalog Number	Wire Range			"D" Nom. Pin Diameter	"P" Length	"L" Length	Common Crimping Die Codes
	Aluminum	ACSR	Dia. Range Min.-Max				
SPT44	2Sol. 3-4 Str. & 4 Comp.	4	.024-.258	4 Sol.	2.00	5.37	EE1-81 Burndy BG, 243 Kerny 5/8 Alcoa 08AH T&B TU (52) Anderson VC5, VC6
SPT24	1-2 Str. 2 Comp. Str.	2	.268-.328		2.00	5.50	
SPT102S	1/0 Str. 1/0 Comp.	1/0	.336-.398	2 Sol.	2.00	5.75	
SPT2010	2/0 Str. 3/0 Comp.	2/0	.388-.448	1/0 Sol.	4.00	7.00	
SPT3010	3/0 Str. 4/0 Comp.	3/0	.442-.502	3/8 Sol.	4.00	7.25	EE1-11A Burndy 249 or 840 Kearny 840 Somerset TX or 76 Alcoa 11 AH Anderson VC6
SPT4020	4/0-250 Str. 250 Comp.	4/0	.511-.575		3.72	7.00	
SPT34940	300-350 Str. 350 Comp.	-	.618-.684	4/0 Sol.	6.00	11.00	

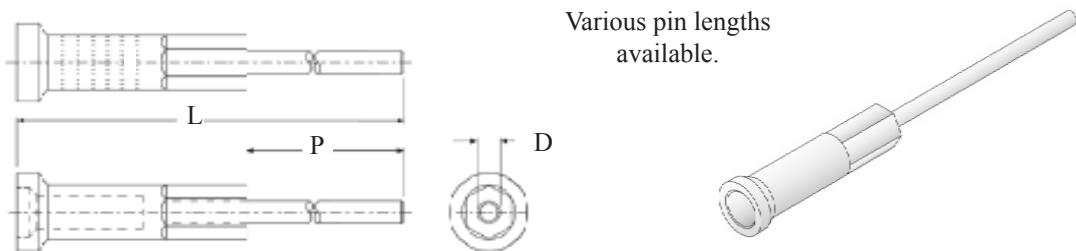



# INSULATED PHASE LINE CONNECTORS

## TYPE LP

In Span Phase Connectors

600V

### DUAL-RATED CONNECTORS FOR ALUMINUM OR COPPER CONDUCTORS

- Designed for use on open wire or multiple cable secondaries to permit readily accessible service connections.
- The connector is constructed of high quality 6061-T6 for strength and conductivity.
- Takes up to four taps. Taps may be added later without interrupting service or removing cover.
- Impact resistant cover and clamp are clearly marked with easy-to-read cable ranges.
- Extended insulating shields on the cover make cable stripping much easier.

Catalog Number	Conductor Range	Conductor Range	L	H	W
	Main AL - CU	Taps AL - CU			
LP4-250	250 MCM - 2	4/0 - 14 or 1/0 ACSR	2.37	2.0	.93
LPC-250	Cover				

*Note:*

- To order the connector and cover together add suffix "C"
- Add suffix "I" to order with co-ox oxide inhibitor.



## TYPE APC

Insulating Cover

- Polyethylene (UV stabilized).
- Eliminates taping.

Cover 1	Fits APC 1/0 & APC 2/0
Cover 400	Fits APC 397 & APC 4/0



Refer to page G-14 for APC connectors.

# ALUMINUM PARALLEL CLAMPS (EXTRUDED)

## TYPE APC/APR

DUAL-RATED CONNECTORS  
FOR ALUMINUM OR COPPER CONDUCTORS

- Pre-filled with CO-OX oxide inhibitor.
- Furnished with high-stress anodized bolts with integrated washers.
- Heavy-duty distribution connectors suitable for use over armor rod.

Fig. 1

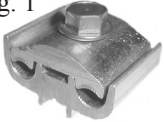
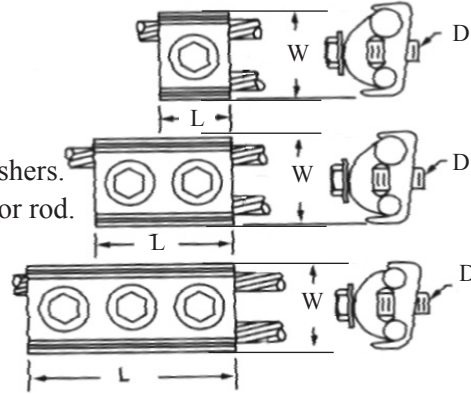
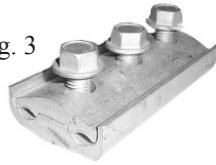

Fig. 2



Fig. 3



Catalog Number	Figure No.	Conductor Range				L	W	D	
		Main "A"	Inches	Tap "B"	Inches	Dimensions - Inches			Bolt Size
			MM2		MM2	Dimensions - (mm)			
APC-1/0I	1	6 sol - 1/0 str.	.17 / .40	6 sol - 1/0 str	.17 / .40	1.312	1.618	3/8	
		6 - 1/0 ACSR	4.11 / 10.11	6 - 1/0 ACSR	4.00 / 10.11	33.27	40.89		
APC-2/0I	1	6 sol - 2/0 str.	.17 / .45	6 sol - 2/0 str	.17 / .45	1.375	1.618	3/8	
		6 - 2/0 ACSR		6 - 2/0 ACSR					
		6 str AR	4.11 / 11.35	6 str AR	4.11 / 11.35	34.80	40.89		
APC-4/0I	1	2 sol - 4/0 str	.25 / .56	2 sol - 4/0 str	.25 / .56	1.500	1.968	3/8	
		4 - 4/0 ACSR		4 - 4/0 ACSR					
		6-4 str. AR	6.35 / 14.30	4 - 4/0 str. Ar	6.35 / 14.30	38.10	50.04		
APC-4/0-2I	2	2 sol - 4/0 str	.25 / .56	2 sol - 4/0 str	.25 / .56	3.00	1.968	3/8	
		4 - 4/0 ACSR		4 - 4/0 ACSR					
		6 - 4 str AR	6.35 / 14.30	6 - 4 str AR	6.35 / 14.30	76.2	50.04		
APR-397I	1	3/0 str - 400 MCM	.47 / .78	6 sol - 3/0 str	.18 / .45	1.687	2.562	1/2	
		3/0 - 397.5 ACSR		6 - 3/0 ACSR					
		4 str - 2/0 str AR	11.94 / 19.84	6 str AR	4.62 / 11.35	44.5	58.67		
APC-397-2I	2	3/0 str - 400 MCM	.47 / .78	3/0 str - 400 MCM	.47 / .78	3.375	2.562	1/2	
		3/0 str - 397.5 ACSR		3/0 str - 397.5 ACSR					
		4 str - 2/0 str AR	11.94 / 19.84	4 str - 2/0 str AR	11.94 / 19.84	85.85	65.02		

Note: For omission of CO-OX oxide inhibitor delete suffix - "I".

# ANIMAL / BIRD GUARDS

## TYPE AG-11

- Made from a specially blended plastisol (PVC) material designed to “lock in” the oils (plasticizer) to promote a longer product life.
- A minimum thickness of 100 mils, with a voltage gradient of 300 volts/mil.
- Gray appearance with added UV stabilizers.
- A fungicide is also added to prevent the formation of mold when installed in a shady location.
- Fits a variety of insulators and comes complete with locking ring to hold it in place.

Catalog	A	B	L
Number	Dimensions - Inches		
AG-11	1	3.87	11.5

Fig 1

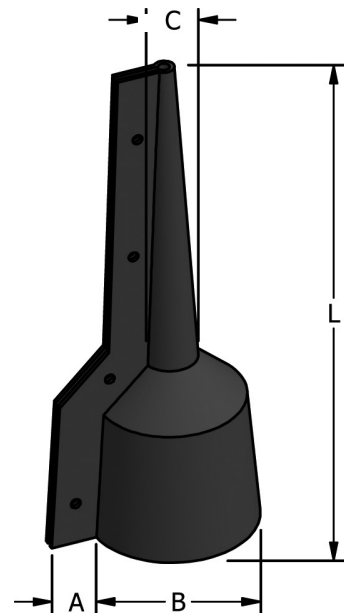

## TYPE AG-RF (Retro-Fit)

- Made from a specially blended plastisol (PVC) material designed to “lock in” the oils (plasticizer) to promote a longer product life.
- A minimum thickness of 100 mils, with a voltage gradient of 300 volts/mil.
- Gray appearance with added UV stabilizers.
- A fungicide is also added to prevent the formation of mold when installed in a shady location.
- Locking ring keeps guard from riding up on the conductors (locks onto first skirt of the insulator). Slit down side to assist installation.

Catalog Number	A	B	C	L	Fig
	Dimensions - Inches				
AG-13RF	1	3.5	1.38	11.6	1
AG-17RF	1	4.4	1.38	18.1	2
AG-16RF	1.25	4.9	2.54	16.0	2

Fig 2

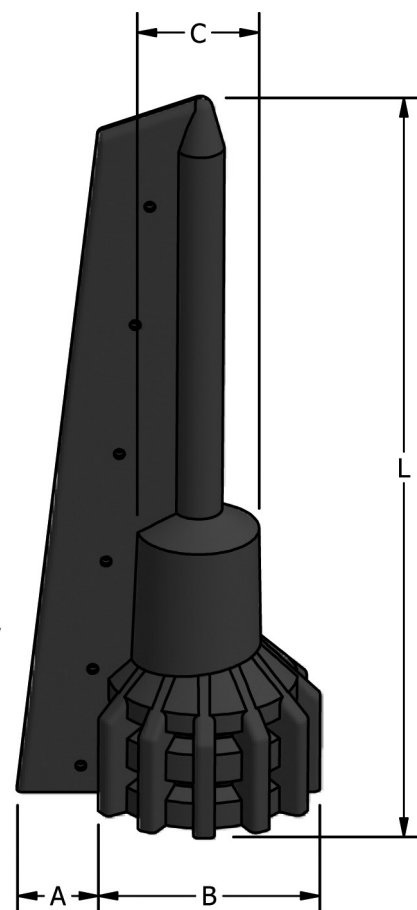

# ANIMAL / BIRD GUARDS

## TYPE AG-17

### Two-Piece

- Made from specially blended plastisol (PVC) material.
- Gray appearance with black added for UV protection.
- Double locking rings keep guard from sliding down on the insulator.
- Expandable base fits many sizes of insulators (O.D.).
- Fits over current limiting fuse.
- Over 17" tall, minimum thickness from 100 to 125 mils (1/8"), with a voltage gradient of 300v/mil.
- A fungicide is added to prevent the formation of mold when installed in shady areas.

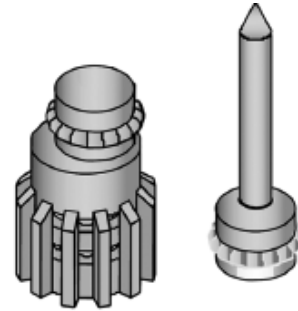

Catalog Number	A	B	L
	Dimensions - Inches		
AG-17	0.75	4.41	18.12

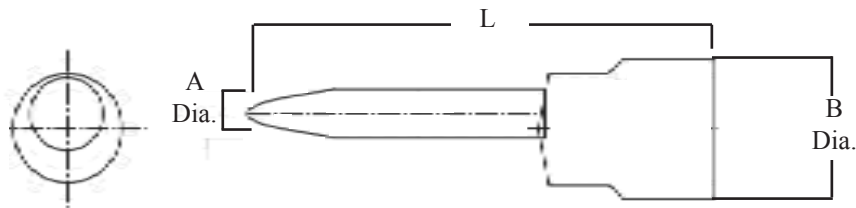

## TYPE AG-17A

- Made from a specially blended plastisol (PVC) material.
- Gray appearance with black added for UV protection.
- Double locking rings keep guard from sliding down on the insulator.
- Expandable base fits many sizes of insulators (O.D.).
- Over 17" tall, minimum thickness from 100 to 125 mils (1/8"), with a voltage gradient of 300v/mil.
- A fungicide is added to prevent the formation of mold when installed in shady areas.

Catalog Number	A	B	L
	Dimensions- Inches		
AG-17A	0.75	4.41	18.12

